

# MEGA LITE<sup>®</sup>

# DRAMA

## EC200



### Product Description:

The Drama EC200 is a color-changing ellipsoidal that uses Lime and Amber plus a Red, Green, and Blue color mixing system. Using lime results in higher lumen output and lumen per watt performance than can be achieved with only primary colors. This high-lumen output and efficiency ensure you can deliver high-quality and efficient white light in a color-mixing application without sacrificing saturation. The DRAMA EC200 is driven by a 200W engine that is quietly cooled, making it suitable for Theatrical and Church applications. It can be paired with four lenses: select from 19°, 26°, 36° and 50° beam angles. The unit comes with one lens included, which is specified when ordering. The unit is ideal for quiet applications such as theaters and churches. It is an affordable option within its class of luminaires, giving you affordability with confidence in its performance.



### RGBAL Color Mixing

The Drama EC200 also offers two unique colors—lime and Amber—each providing additional color-mixing options. Lime LEDs enable higher lumen output and lumen per watt performance, and Amber allows you to make warmer tones that you wouldn't otherwise be able to.

### Even Field Coverage

The unique LED grouping and lensing allow for a very even color field, minimizing the color shift seen only in costly fixtures.

### Quiet Operation Ideal for theater settings

The combined heatsink and forced air fan work at a very low noise level, making the unit ideal for theatrical applications.

## Mechanical Specifications

---

Power Connection:	True-One type connection to NEMA 5-15
Signal Connection:	5 Pin XLR in and out
Lens Angle:	19°, 26°, 36°, 50° (One lens included at time of purchase)
Fastening System:	Single Mounting Yoke

## Electrical Specifications

---

Light Source:	1 X 200W COB LED
Color Temperature:	6024k
CRI (Warm White):	64
Lumen Output:	5290 lm @ 19° 5468 lm @ 26° 5391 lm @ 36° 5590 lm @ 50°
Power Supply:	100-240VAC 50/60Hz
Power Consumption:	185w   1.68 amps @110v

## Control System

---

Control Protocols:	DMX 512
Channel Modes:	3 Modes of Operation Mode 1: 5 Channel mode Mode 2: 6 Channel mode Mode 3: 8 Channel mode
Display:	Digital

## Size and Weight

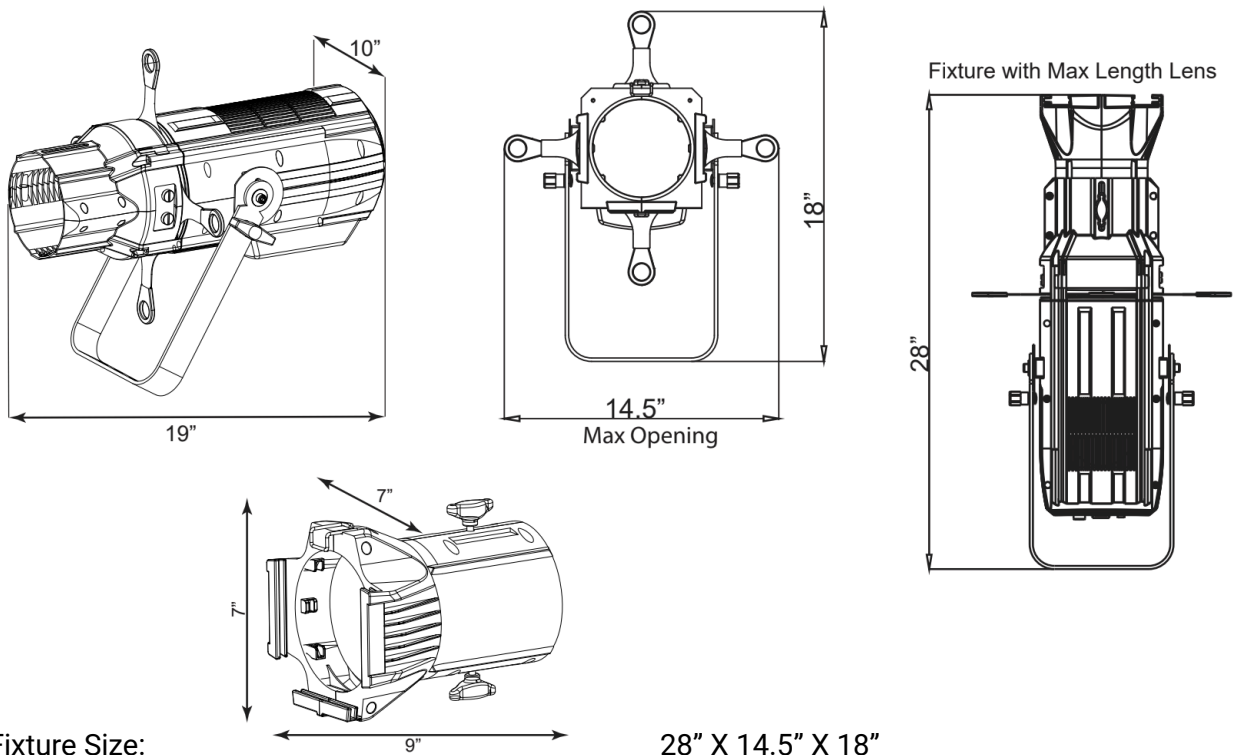

Fixture Size: 28" X 14.5" X 18"  
 Fixture Weight: 11lb  
 Packaged Size: \*27" X 12" X 12"  
 Packaged Weight: 17lb

\*Lens packaged separately

## Color Rendering

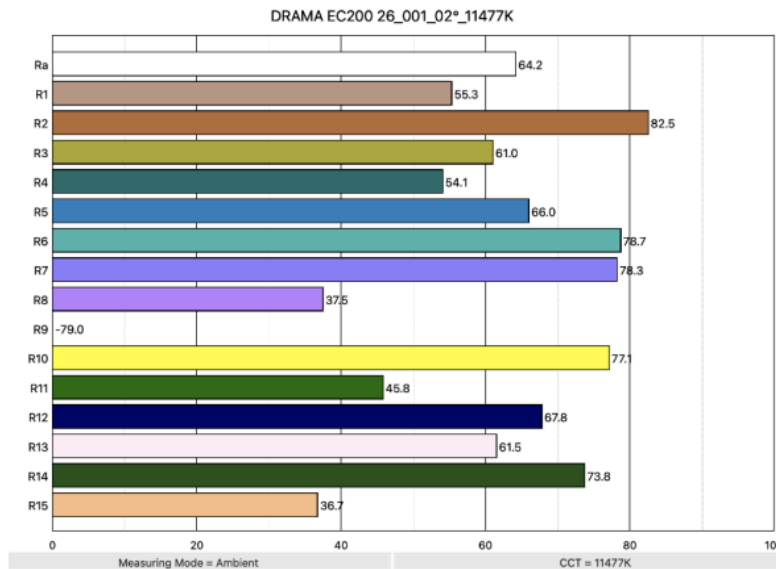

# Beam Angles

19°

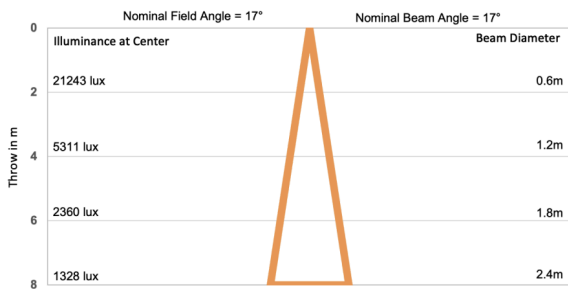
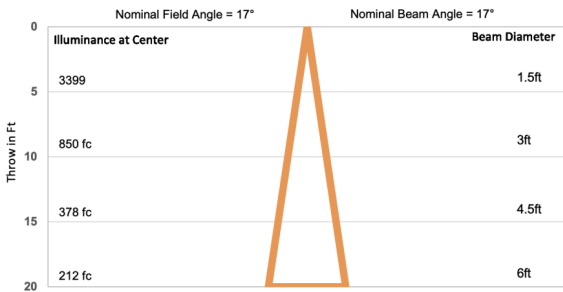

26°

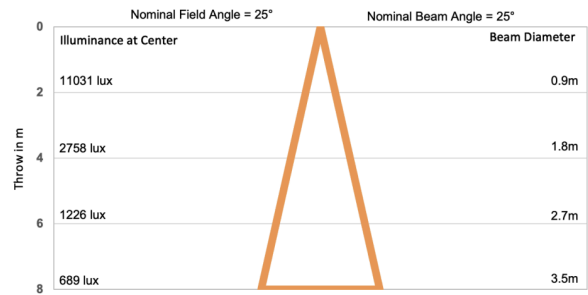
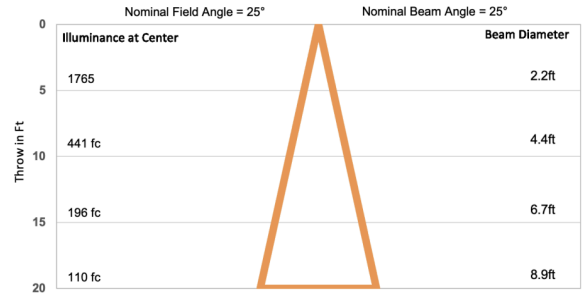

36°

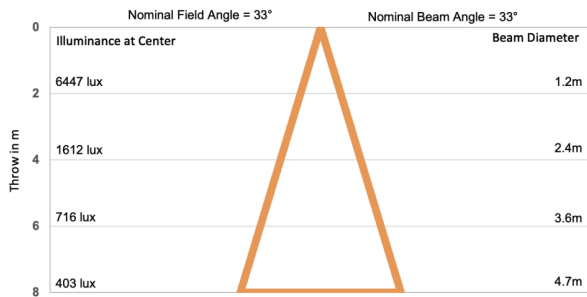
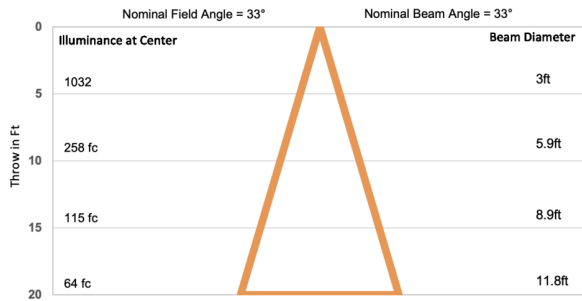

50°

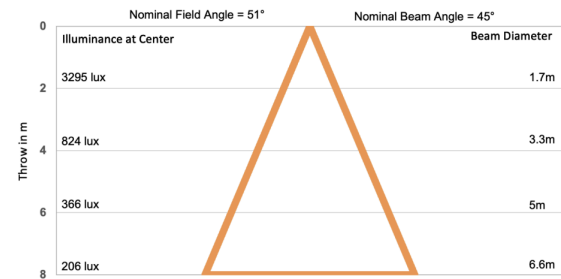
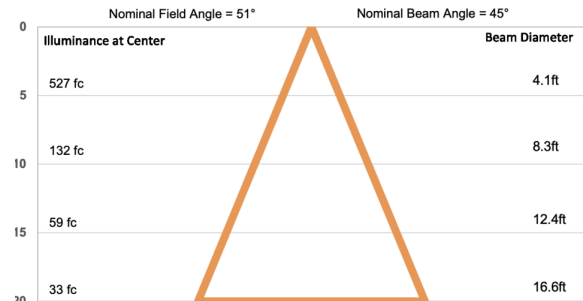

## Included Items

---

Drama EC200	7062
Gobo Holder	7062-GOB
Color Holder	7062-GEL
True-One Power Cable	
One Lens included at the time of purchase	

## Accessories:

---

Lens 19° Angle	7062-LEN-19
Lens 26° Angle	7062-LEN-26
Lens 36° Angle	7062-LEN-36
Lens 50° Angle	7062-LEN-50

## Customer Service

---

MEGA-Lite has a customer support line to provide set-up help and answer any questions should you encounter a problem. Please visit our website for any other technical documents related to this issue. For service-related issues, please contact our service department at **[service@mega.lighting](mailto:service@mega.lighting)**

Operating Hours:  
Phone:  
Email:

Monday - Friday 9AM - 6PM CST  
(210) 684-2600  
[Sales@mega.lighting](mailto:Sales@mega.lighting)



18662 Bandera Rd  
Helotes, TX 78023  
Phone (210)684-2600 / Fax (210)855-6279  
[www.mega.lighting](http://www.mega.lighting) / [info@mega.lighting](mailto:info@mega.lighting)